

TECHNICAL BULLETIN

N 82 - 2019. 02

E85

New glazing shims for supports
triple glazing E85 up to 80 kg

content:

- PROFILES 1:1
- DETAILS

- ACCESSORIES

ETEM

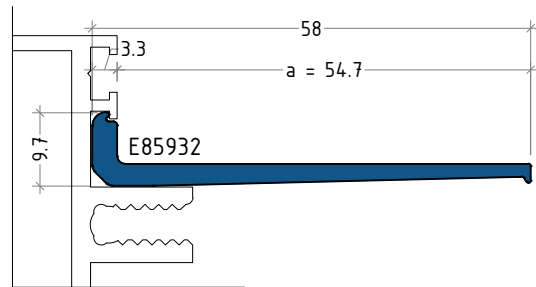
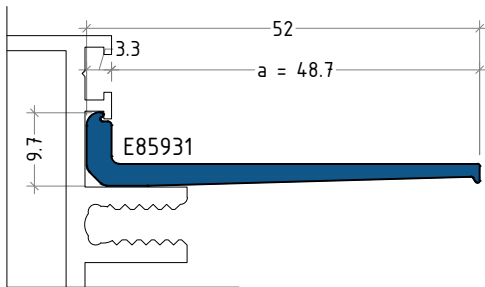

code	accessory code	utility length /a/	load bearing capacity of both supports
E85931	ET071440.00	48.7 mm	800 N
E85932	ET071441.00	54.7 mm	800 N

transom 3rd level

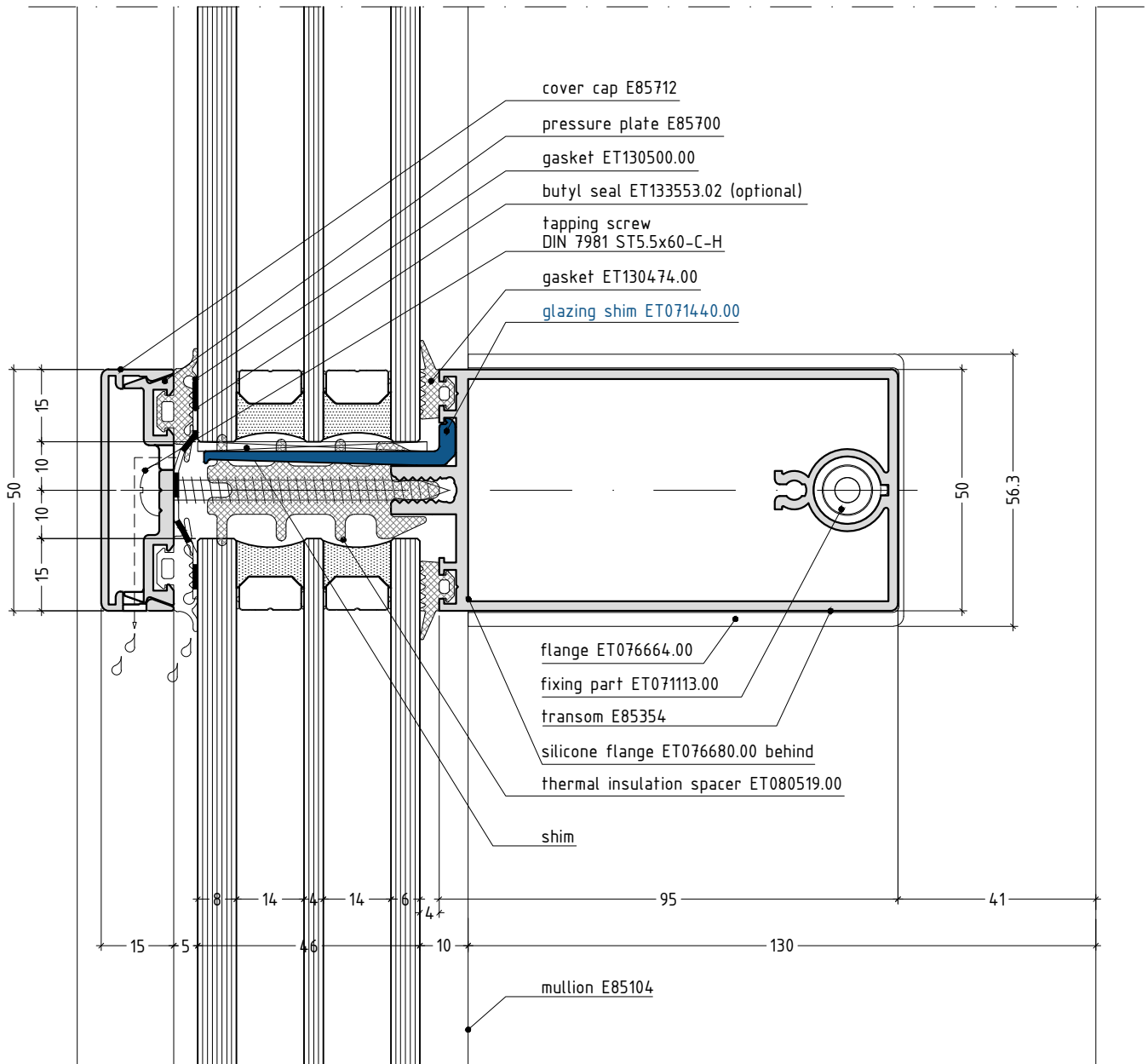
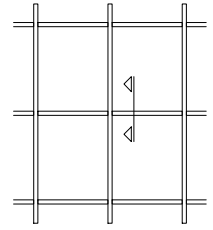

Note:
Infill could be with different thickness, but it depends on the project.

scale 3/4

E85CP5.01

transom 3rd level

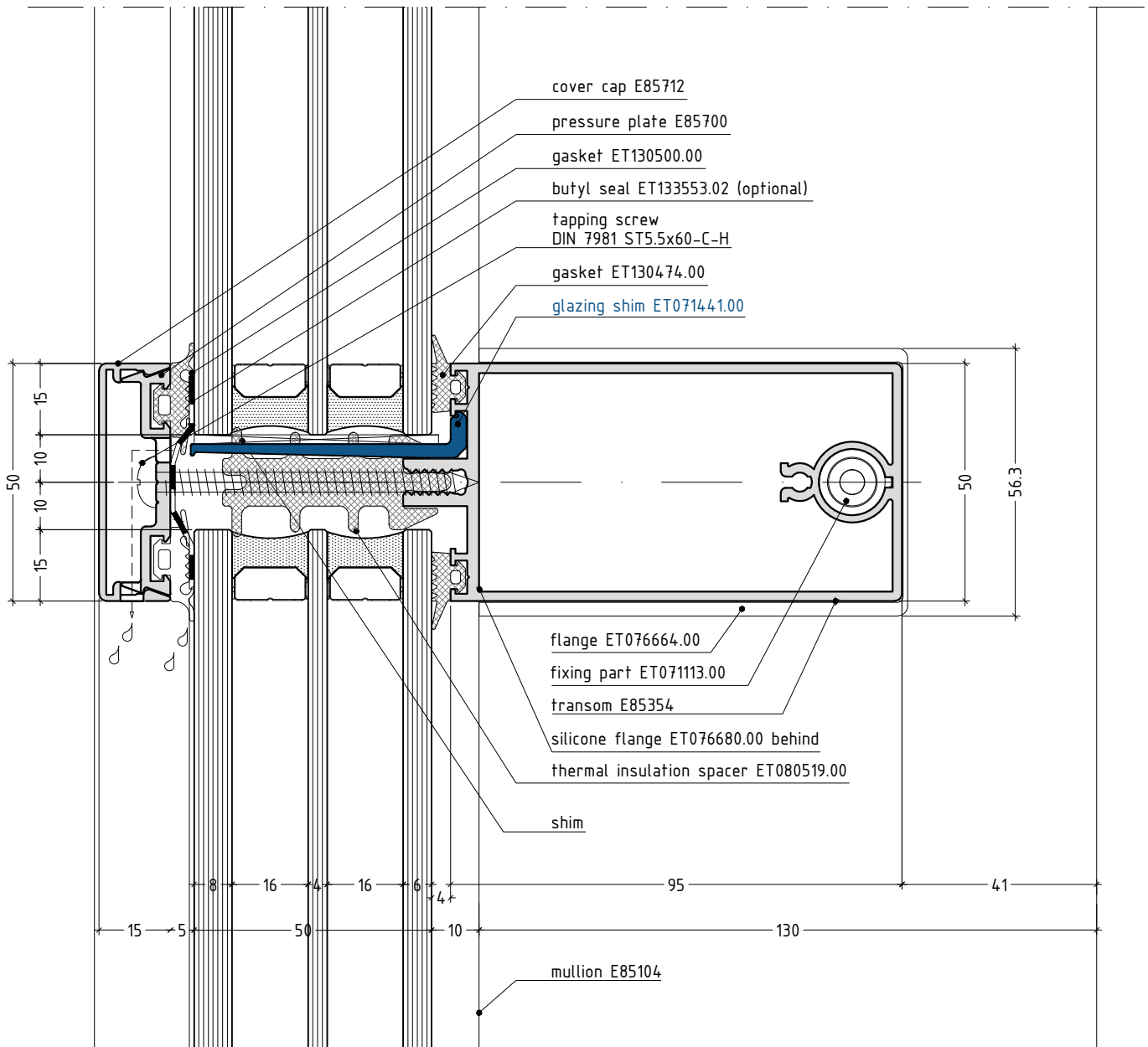
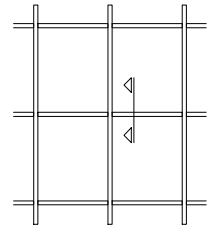

Note:
Infill could be with different thickness, but it depends on the project.

scale 3/4

E85CP5.02

curtain wall system

E85

projected thermo-break window for tripple glazing

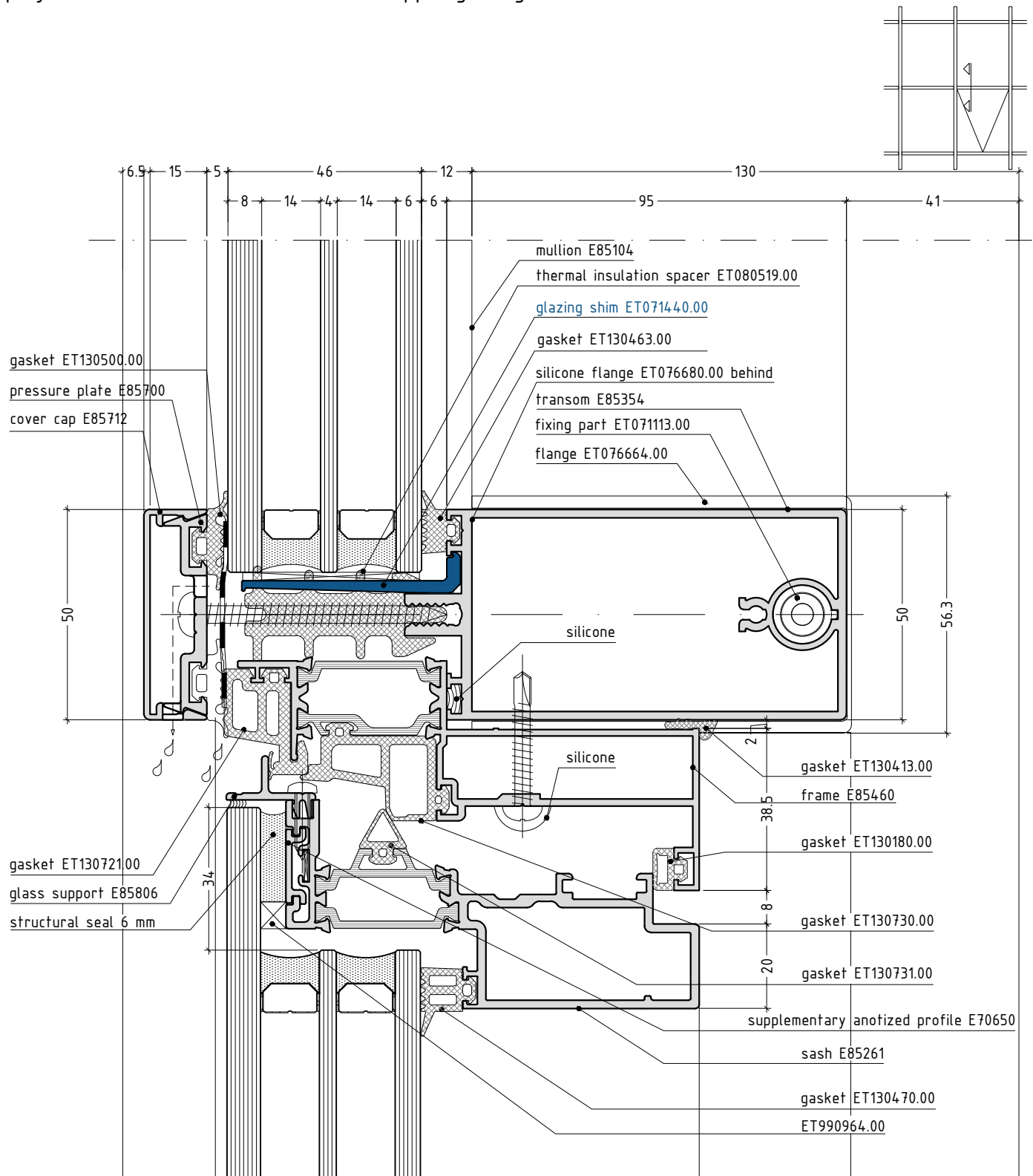

Note:
For parallel opening the sash is the same, only the hardware is different.
Infill could be with different thickness, but it depends on the project.

scale 3/4

E85CP5.03

projected thermo-break window for tripple glazing

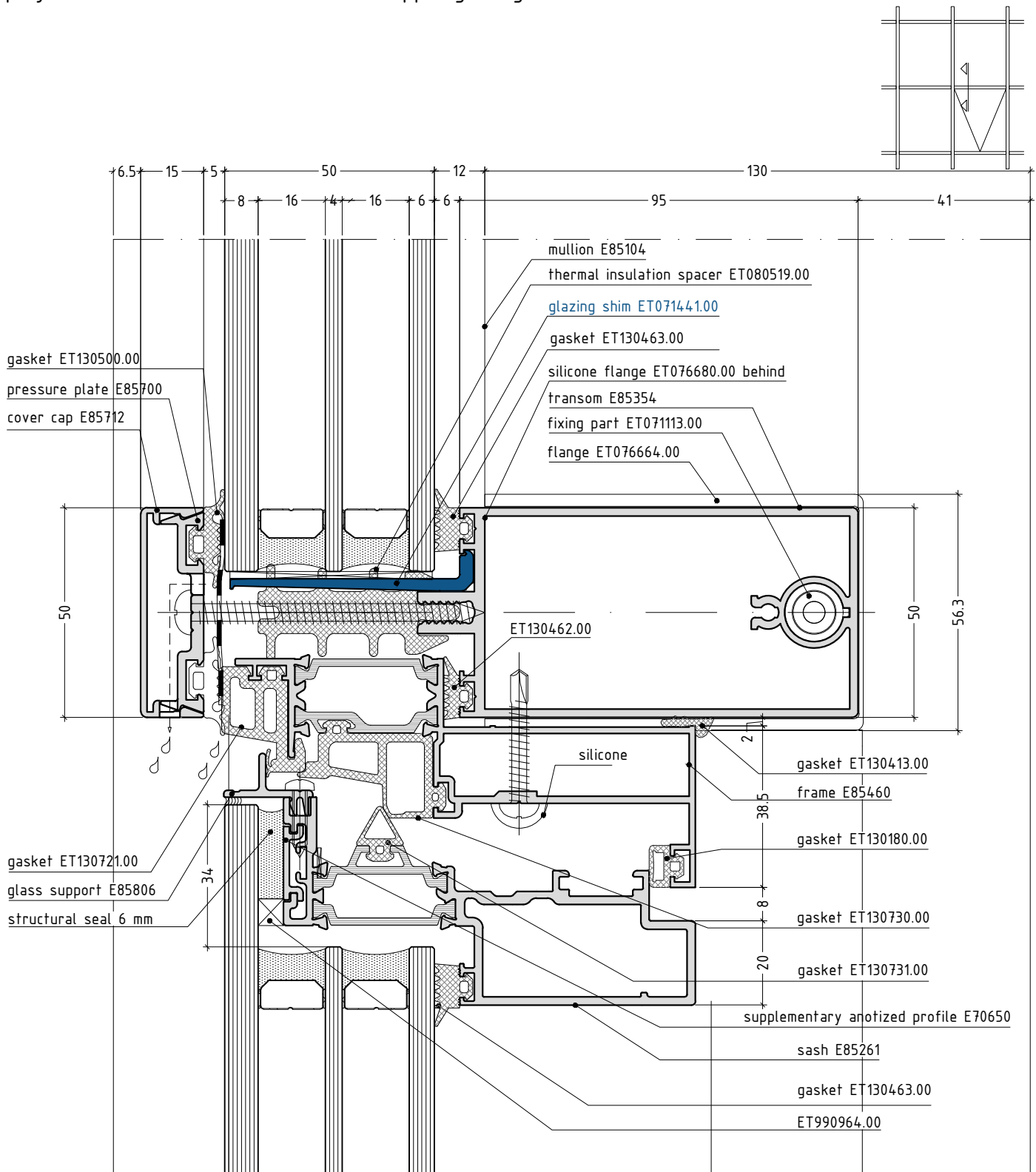

Note:
 For parallel opening the sash is the same, only the hardware is different.
 Infill could be with different thickness, but it depends on the project.
 scale 3/4

E85CP5.04

curtain wall system

E85

support for thermo-break window for triple glazing

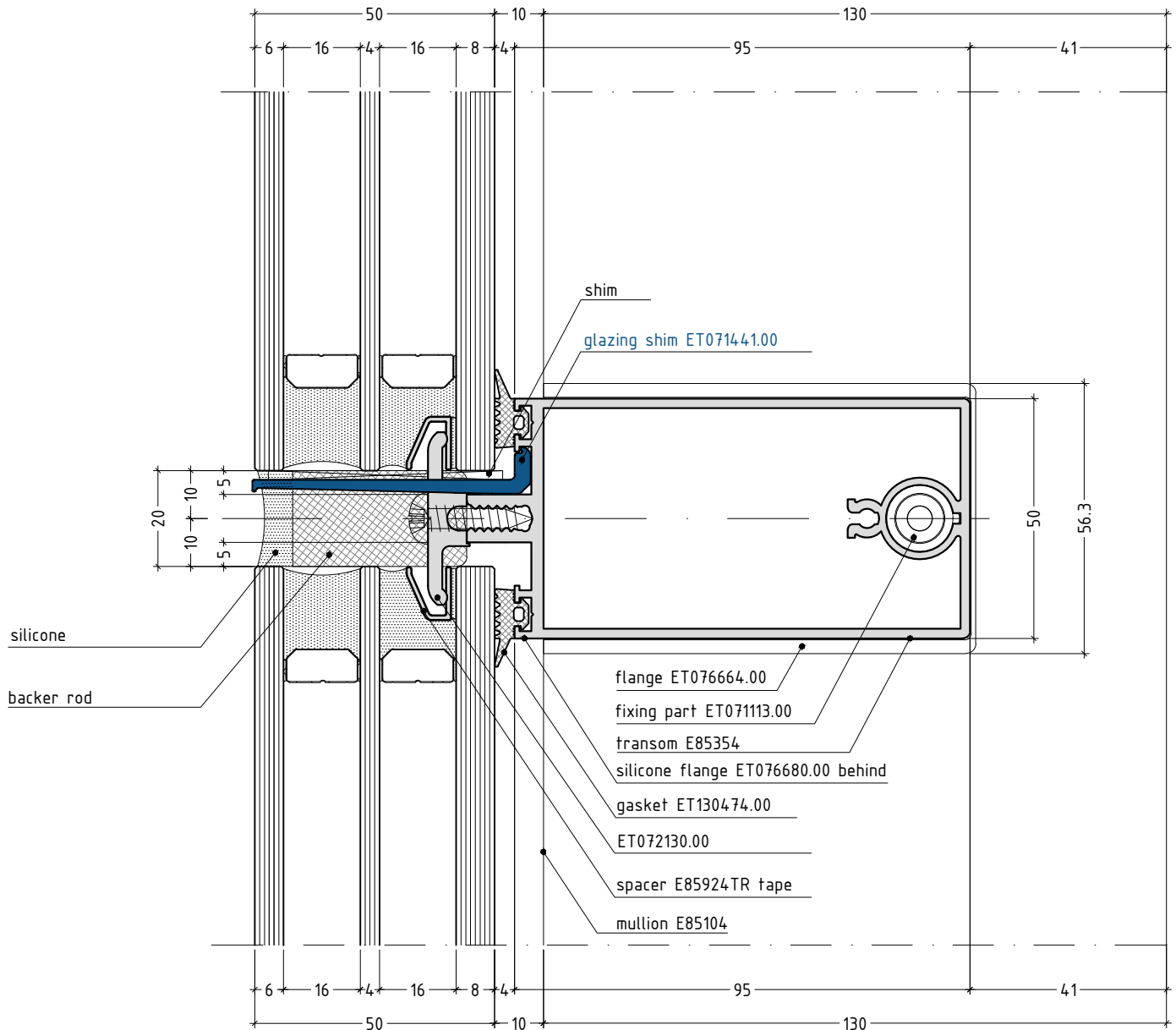
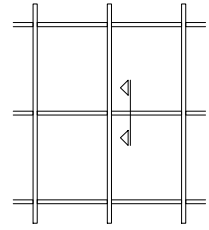

Note:
For parallel opening the sash is the same, only the hardware is different.
Infill could be with different thickness, but it depends on the project.

scale 3/4

E85CP5.07

curtain wall system

E85

projected thermo-break window for tripple glazing

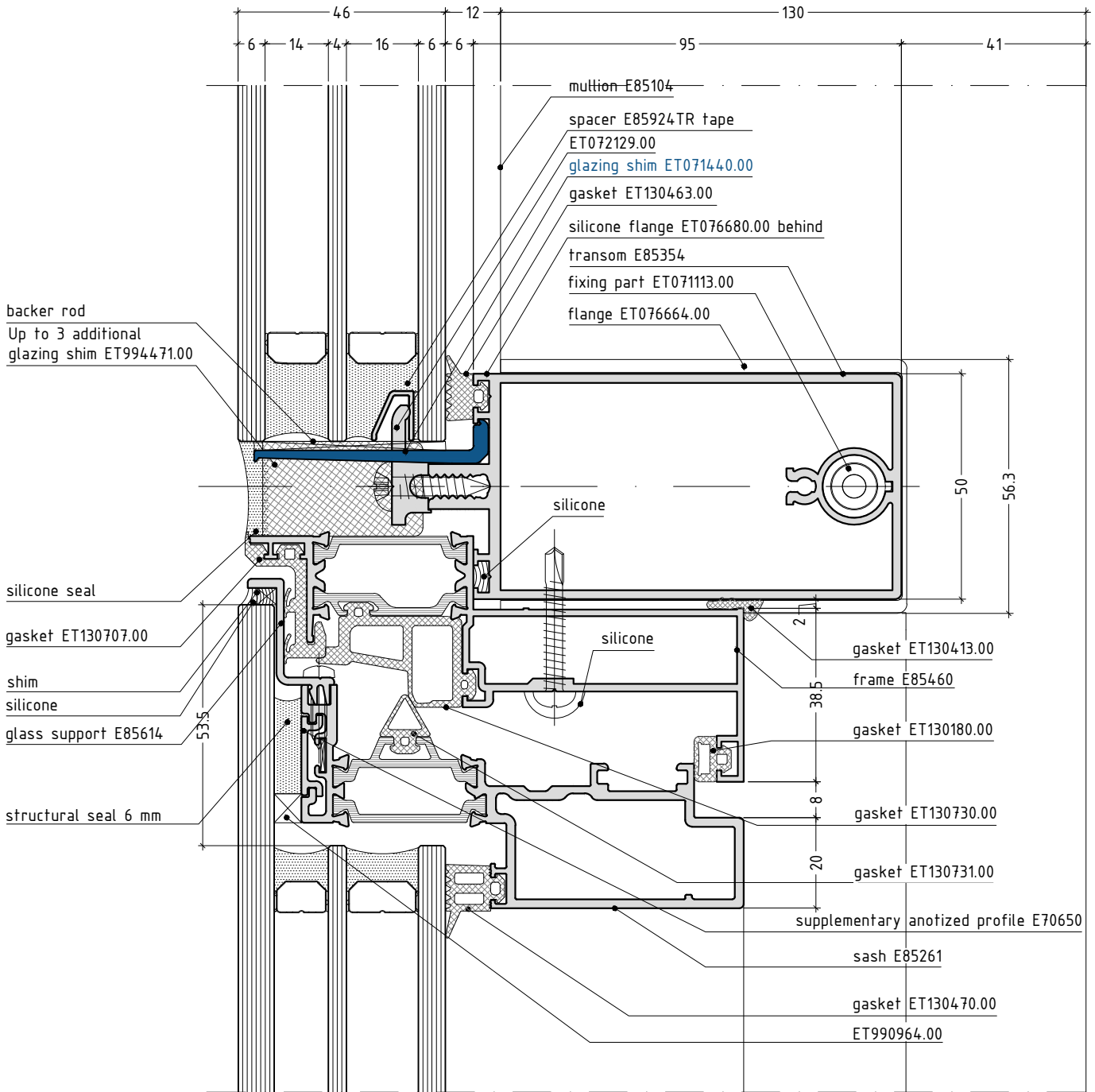
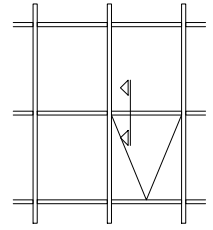

Note:
For parallel opening the sash is the same, only the hardware is different.
Infill could be with different thickness, but it depends on the project.

scale 3/4

E85CP5.08

curtain wall system

E85

support for thermo-break window for triple glazing

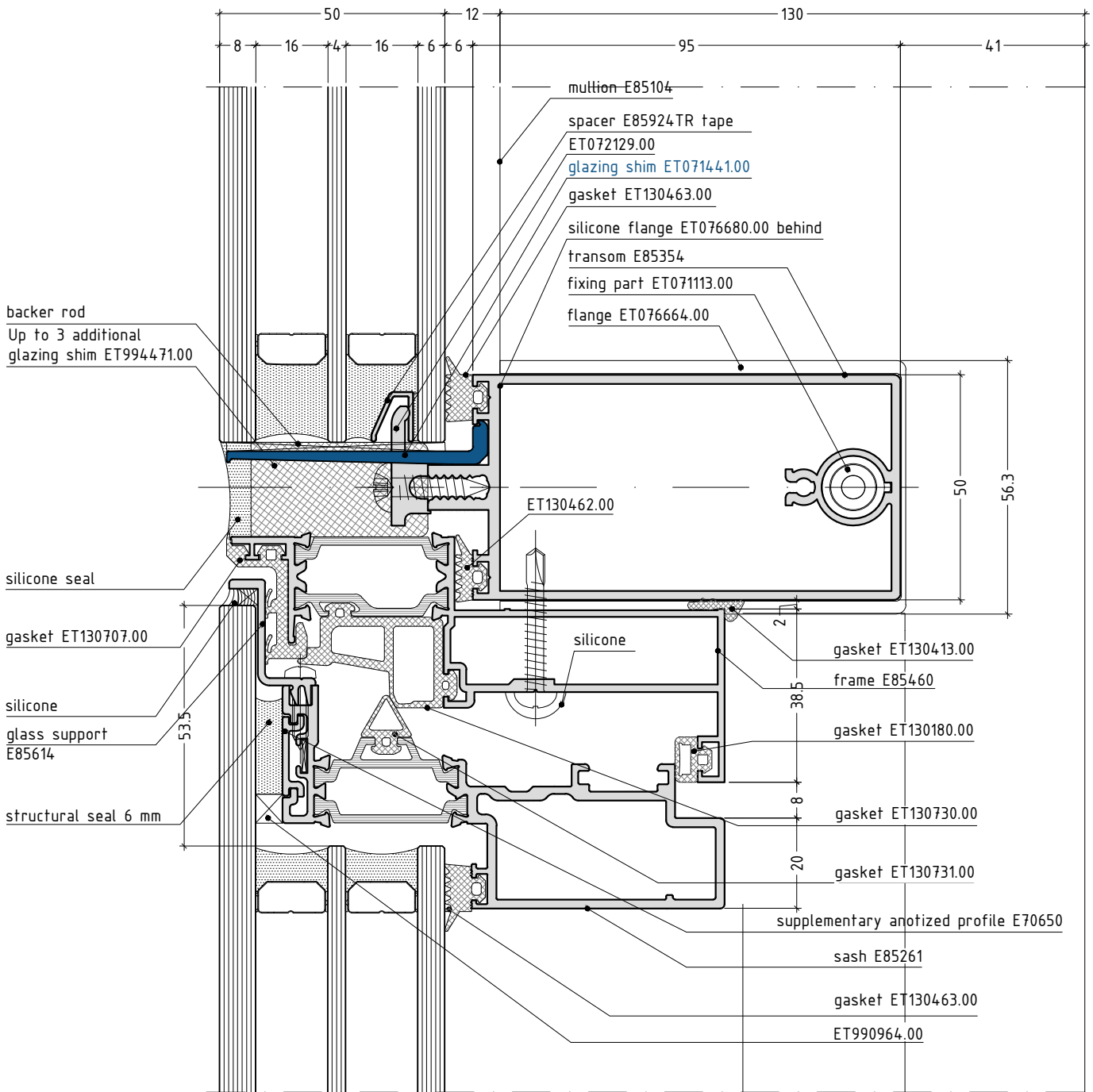
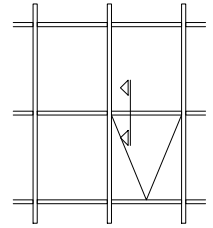

Note:
For parallel opening the sash is the same, only the hardware is different.
Infill could be with different thickness, but it depends on the project.

scale 3/4

E85CP5.09

curtain wall system

E85

code/description	package/pcs	colour
ET 071440.00	100	MF

aluminium glazing shim
48.7 mm for transoms
3rd level drainage

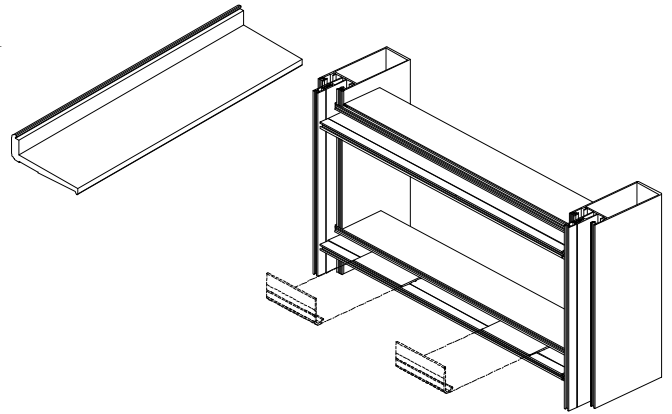

ET 071441.00	100	MF
---------------------	-----	----

aluminium glazing shim
54.7 mm for transoms
3rd level drainage

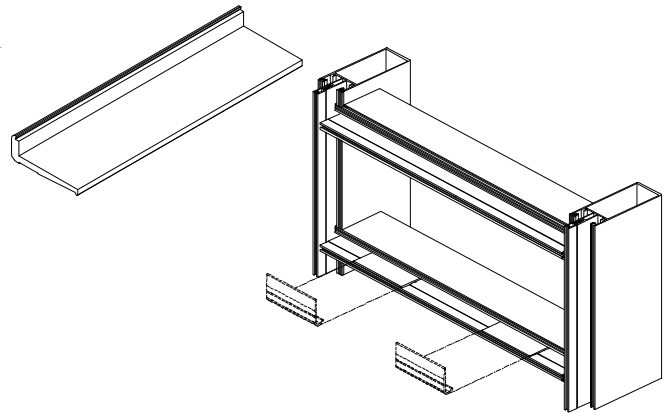

--	--	--

--	--	--

A85-01